

## Door Bottom Sweeps (Cont.)

### 3452\_V

AVAILABLE FINISHES:  
A, BDG, C, D, G, PW, SN

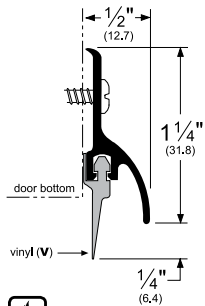

### 3452\_NB

AVAILABLE FINISHES:  
BDG, C, D, G, PW, SN

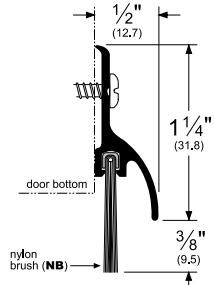

### 345\_NB

AVAILABLE FINISHES:  
A, BDG, D, G, PW

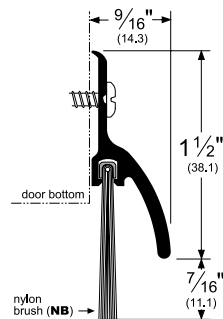

### 293100\_NB

AVAILABLE FINISHES:  
C, D

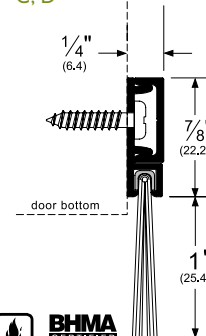

### 18061\_NB

AVAILABLE FINISHES:  
C, D, G, SN

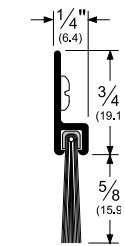

### 18100\_NB

AVAILABLE FINISHES:  
C, D, G, PW

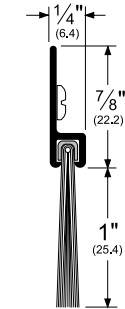

### 18137\_NB

AVAILABLE FINISHES:  
C, D, G, PW

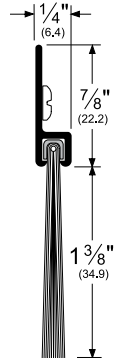

### 90062\_NB

AVAILABLE FINISHES:  
C, D

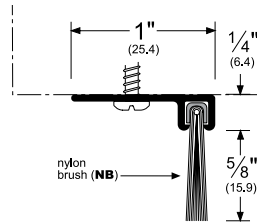

### 90100\_NB

AVAILABLE FINISHES:  
C, D, G  
• For hollow metal doors with inverted channel

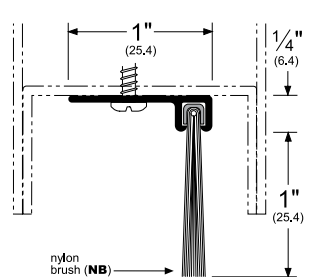

## Stainless Steel Door Bottom Sweeps

### 315SSN

AVAILABLE FINISH: SS (#4 Finish)

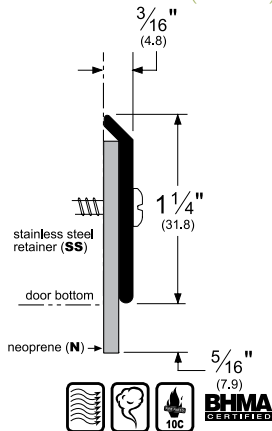

### 321SSN

AVAILABLE FINISH: SS (#4 Finish)

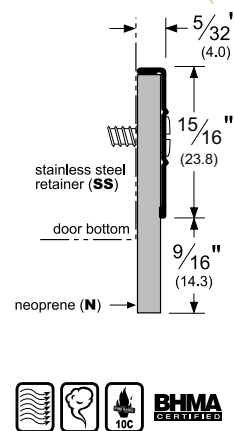

### 3151SSN

AVAILABLE FINISH: SS (#4 Finish)

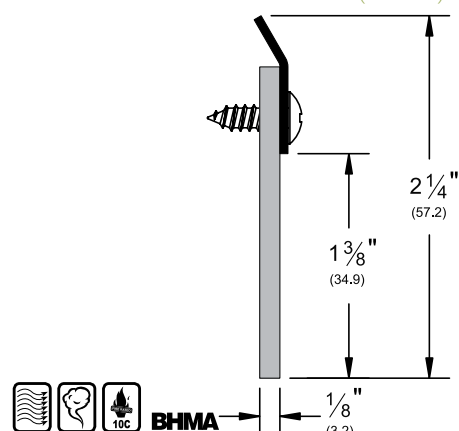

NOTE: Products shown in this section may not be drawn to scale.

AVAILABLE FINISHES FOR PRODUCTS SHOWN ON THIS PAGE (see General Information section for finish chart)

A (Mill Finish Aluminum) BDG (Bright Dip Gold Anodized) C (Clear Anodized) D (Dark Bronze Anodized) G (Gold Anodized) PW (Painted White)  
SN (Satin Nickel Anodized) SS (See Individual Part)